

Linked Drawings and Specifications Index

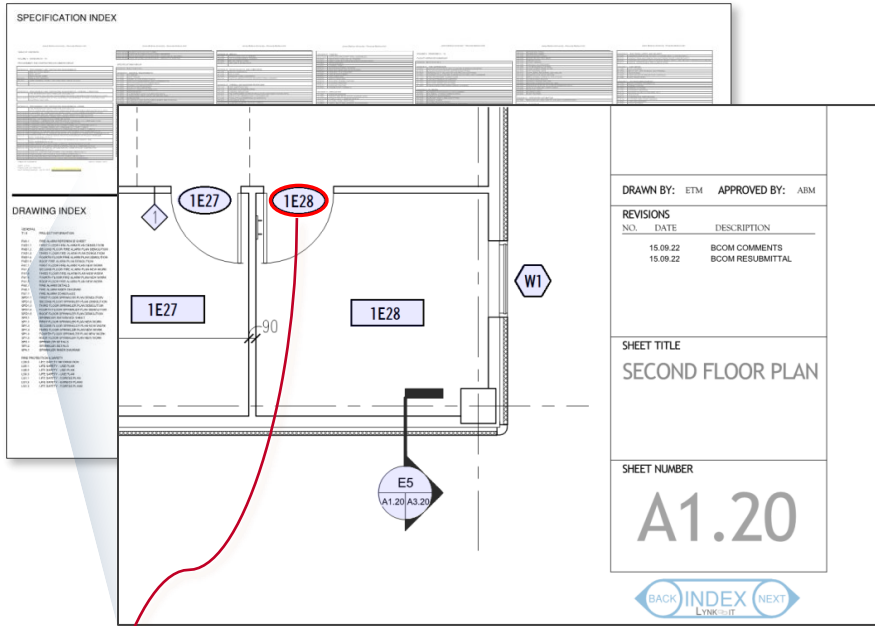

Linked to Zoomed in View

1E22	915	2135	45	A	STL.	J1	H2	IT	112	DP3	
1E23	915	2135	45	A	STL.	J1	H1	IT	132	DP3	
1E24	PR 915	2135	45	E	STL.	J4	H4	EXT	6	DP3 **	
1E24A	PR 865	2135	45	B	STL.	J1	H1	IT	128	DP3	
1E25	915	2135	45	B	STL.	J1	H1	IT	106	DP3	
1E26	915	2135	45	A	STL.	J1	H1	IT	123	DP3	
1E27	915	2135	45	A	STL.	J1	H1	IT	112	DP3	
1E28	915	2135	45	A	STL.	J1	H1	IT	101	DP3	
1E29	915	2135	45	A	STL.	J1	H1	IT	101	DP3	
1E30	915	2135	45	A	STL.	J1	H1	IT	111	DP3	
1E33	915	2135	45	A	STL.	J1	H1	IT	114	DP3	
1EC1	915	2135	45	B	STL.	J1	H1	IT	109	DP3	
1EC1A	915	2135	45	F	STL.	J4	H4	EXT	9	DP3 **	
1EC3	915	2135	45	B	STL.	J1	H1	IT	108	DP3	
1EC4	PR 1220 / 305	2135	45	E	STL.	J4	H4	EXT	7	DP3 **	

All Inclusive Hyperlinking

On the PDF's of your construction drawings, we link all callouts, details, equipment, fixtures, cut sheets, ASI's, etc. that can be linked so your team can start construction with the maximum level of functionality in your drawings. We build a custom index page that contains all drawings and a full Table of Contents for the Specifications so that your team can access any document from one starting location.

Included in our Services

- Linked Drawings and Specifications Index
- Back/Next (page flip) and Return to Index buttons on each page
- Architectural
- Structural
- Civil
- MEP including Lighting
- Specialty Equipment

See Page 2 for more detail...

Other Services

- Calibrate viewport scales for accurate measurement
- List of all detail instances
- Toggle Menus: Flip between arch., MEP, etc. on floorplans
- Ongoing maintenance of ASI's, bulletins, and RFI's

Linked to Zoomed in Views

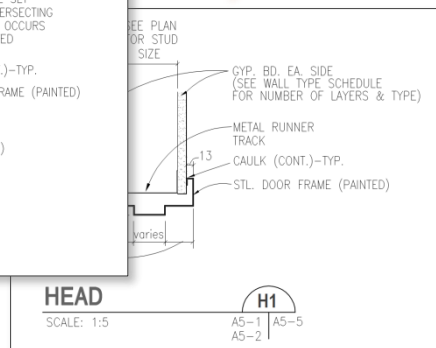
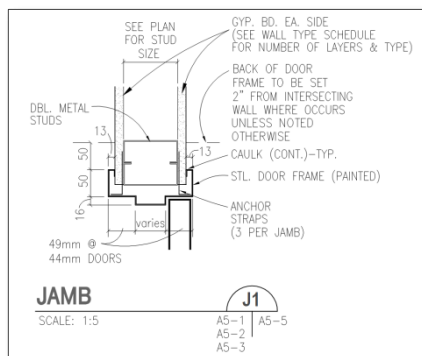

Hardware Schedule			
Set 101			
Doors: 1E28, 1E29			
1 Floor Closer	626 PH SC 28N 95	626	RF
1 Pivot	340xAP3 1/4" Longer Pivot Pin	626	RF
1 Pull Plate	107x70C		US32D RC
1 Push Plate	70C		US32D RC
Set 102			

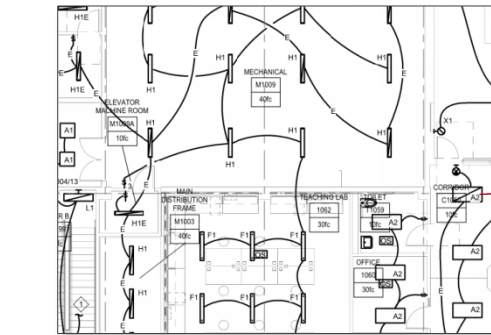
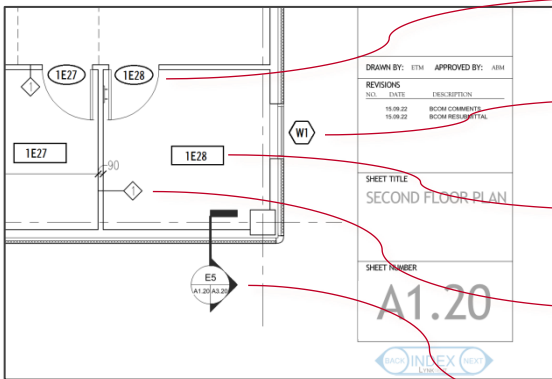
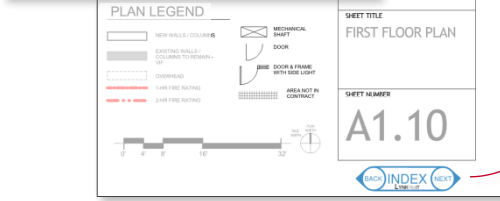
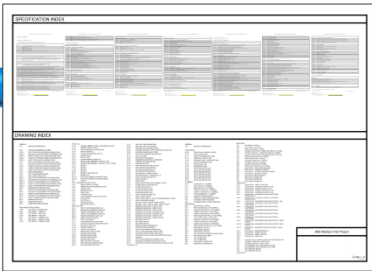

Architectural

Lighting

Electrical

Mechanical

Plumbing

Civil/Structural

Kitchen/Lab/Specialty Equipment

Linked Drawing and Specifications Index

Back/Next (page flip) and Return to Index buttons on each page

Doors linked to zoomed in view of schedule

Windows linked to zoomed in view of schedule/details

Room finishes linked to zoomed in view of finish schedule

Partitions linked to zoomed in view of partition details

Detail callouts linked to zoomed in view of details

Lights linked to zoomed in view of luminaire schedule

Electrical panels linked from plans to panel schedules

Mechanical equipment linked to zoomed in view of schedules

Plumbing fixtures linked to zoomed in view on schedule

Detail callouts linked to zoomed in view of detail

Equipment plans linked to schedules or cut sheets

Door schedule linked to zoomed in view of details and HW specifications

